

# Ray hộp 7273011 NL: 500mm

808 SERIES

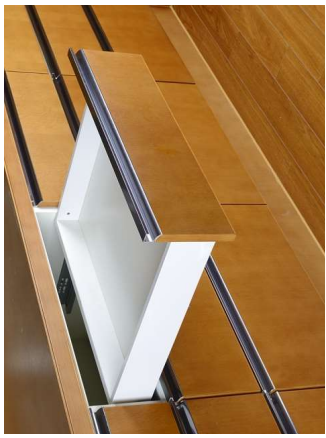

- Extra slender side panel, maximizing internal drawer space
- Color White (8081), Grey (8082)
- Fully synchronised motion, smooth opening and closing
- Quick and easy assembly and dismantling
- Handy 3D three dimensional front adjustment
- Dynamic loading 40 Kg
- Optional tilting adjustment

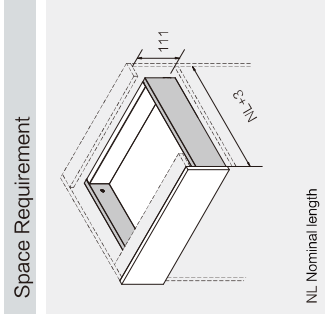

## Order information

Kit package		White (8081) , Grey(8082)	
Nominal length NL	Set/cdn	Soft close drawer item NO.	Set/cdn
270mm	1	808 A89270	10
300mm	1	808 A89300	10
350mm	1	808 A89350	10
400mm	1	808 A89400	10
450mm	1	808 A89450	10
500mm	1	808 A89500	10
550mm	1	808 A89550	10

## Drawer Sides Industrial Package

White (8081) , Grey(8082)	Set/cdn
808CB89270	10
808CB89300	10
808CB89350	10
808CB89400	10
808CB89450	10
808CB89500	10
808CB89550	10

## Bottom Fixing-brackets left/right

Industrial Package	Set/cdn
808BB1000M	100

## Front Fixing-brackets

Industrial Package	Set/cdn
Pre-zinc Steel	400
808Q104	400

## Screw

Industrial Package	Set/cdn
Zinc Plated	500
908LS114	500

Sides Industrial Package		Pre-zinc Steel	
Nominal length NL	Set/cdn	Soft close drawer item NO.	Set/cdn
270mm	10	808CJH270	10
300mm	10	808CJH300	10
350mm	10	808CJH350	10
400mm	10	808CJH400	10
450mm	10	808CJH450	10
500mm	10	808CJH500	10
550mm	10	808CJH550	10

## The basic components

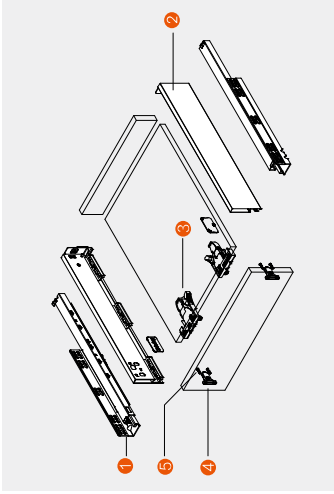

## Installation dimensions (mm)

Nominal Slide Length=NL Internal Cabinet Depth=L=L+NL+3

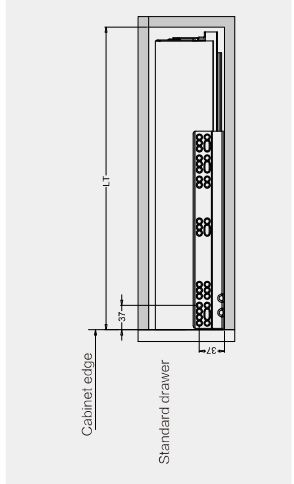

## Drawer installation dimensions (mm)

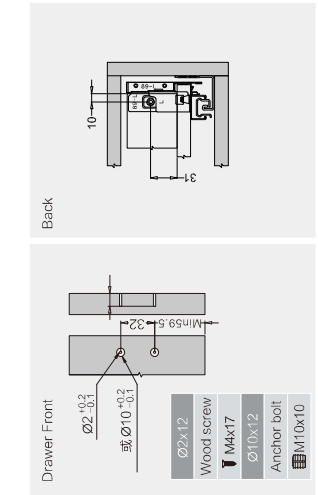

## Screw Positions of the Sides (mm)

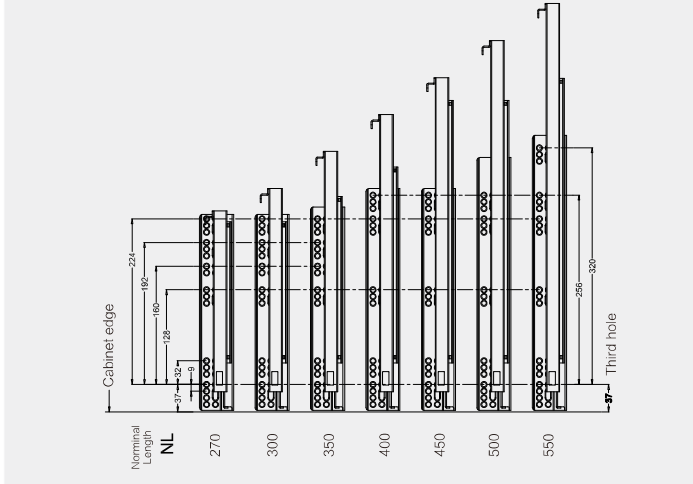

## Installation Dimensions (mm)

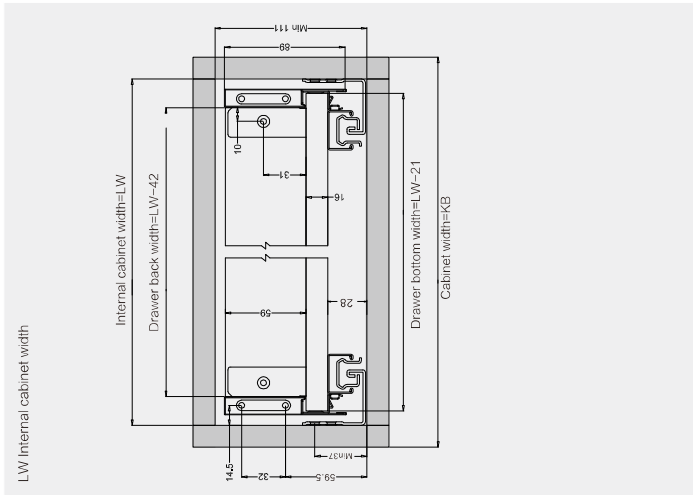

## Drawer Back and Bottom Dimensions (mm)

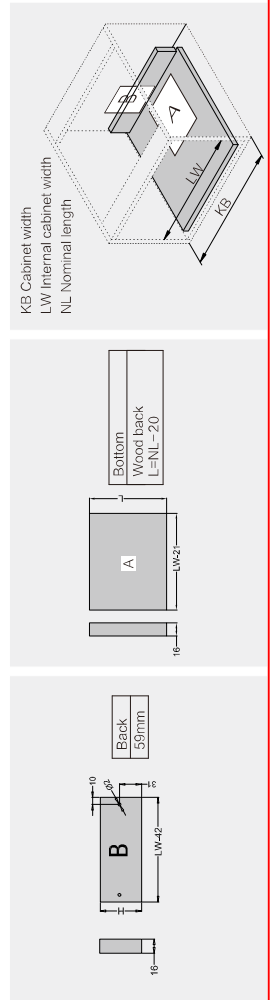

# Ray hộp âm 7273021

## NL: 500mm

808 SERIES



- Extra slender side panel , maximizing internal drawer space
- Color White (8081), Grey(8082)
- Fully synchronised motion , smooth opening and closing
- Quick and easy assembly and dismantling
- Handy, 3D three dimensional front adjustment
- Dynamic loading 40 Kg
- Optional tilting adjustment

### Space Requirement

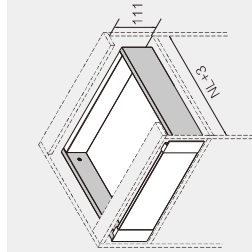

NL Nominal length

### Order information

Kit package		Soft close drawer		Set/cdn
Nominal length NL	White (8081) , Grey(8082)	Item NO.	Soft close drawer Item NO.	Set/cdn
270mm	808 A89270N	1	808CJH270	10
300mm	808 A89300N	1	808CJH300	10
350mm	808 A89350N	1	808CJH350	10
400mm	808 A89400N	1	808CJH400	10
450mm	808 A89450N	1	808CJH450	10
500mm	808 A89500N	1	808CJH500	10
550mm	808 A89550N	1	808CJH550	10

### Drawer Sides Industrial Package

Nominal length NL	White (8081) , Grey(8082)	Item NO	Set/cdn
270mm	808CB89270	10	
300mm	808CB89300	10	
350mm	808CB89350	10	
400mm	808CB89400	10	
450mm	808CB89450	10	
500mm	808CB89500	10	
550mm	808CB89550	10	

### Locking brackets L/R

Item NO.	808BB1000M	Set/cdn	Industrial Package
808-89-1 Front Fixing brackets L/R	White, Grey	25	Industrial Package
808-1 Front section	White (8081) , Grey(8082)	25	Industrial Package
Screw ( $\phi$ 4x25 )	Zinc Plated	500	Industrial Package
808 Bottom fixed	White	400	Industrial Package

Sides Industrial Package		Soft close drawer		Set/cdn
Nominal length NL	Pre-zinc Steel	Item NO.	Soft close drawer Item NO.	Set/cdn
270mm	808CJH270	10	808CJH270	10
300mm	808CJH300	10	808CJH300	10
350mm	808CJH350	10	808CJH350	10
400mm	808CJH400	10	808CJH400	10
450mm	808CJH450	10	808CJH450	10
500mm	808CJH500	10	808CJH500	10
550mm	808CJH550	10	808CJH550	10

### The basic components

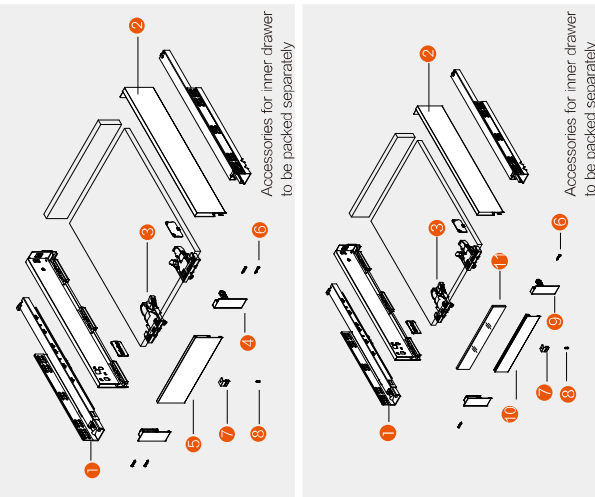

Screw ( $\phi$ 3.5x13 )		Industrial Package	
Item NO.	908LS116	Set/cdn	500
808-89-2 Front Fixing brackets L/R		Industrial Package	
White, Gray		25	
808-2 Front section		Industrial Package	
White (8081) , Grey(8082)		25	
Item NO. : 808NCMB02		Set/cdn	

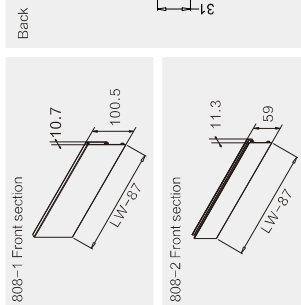

### Screw Positions of the Sides (mm)

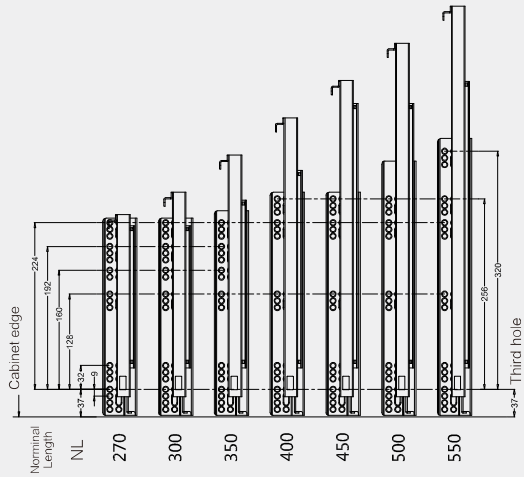

808-89 Glass Front		Industrial Package	
Item NO.	808BLVB01	Set/cdn	10
Glass front			
Glass boxside			

### Drawer Back and Bottom Dimensions (mm)

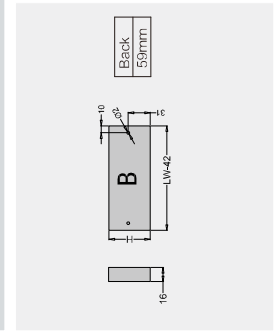

### Normal Side Length=NL Internal Cabinet Depth=L<sub>T</sub>=NL+3

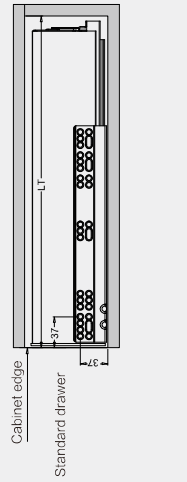

### Installation Dimensions (mm)

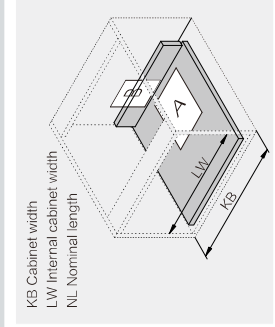
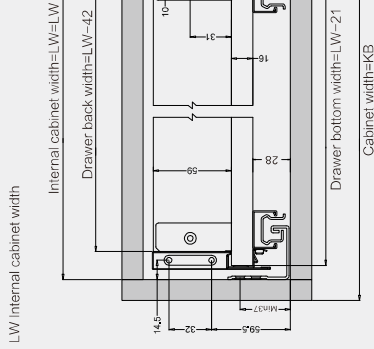

# Ray hộp 7273014 NL: 500mm

808 SERIES



- Extra slender side panel, maximizing internal drawer space
- Color White (8081), Grey (8082)
- Fully synchronised motion, smooth opening and closing
- Quick and easy assembly and dismantling
- Handy 3D three dimensional front adjustment
- Dynamic loading 40 Kg
- Optional tilting adjustment

## Space Requirement

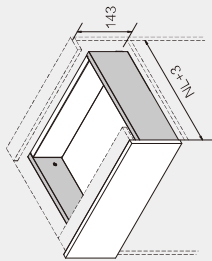

NL Nominal length

## Order information

Kit package		White (8081) , Grey (8082)	
Nominal length NL	Set/cdn	Soft close drawer item NO.	Set/cdn
270mm	1	808 A121270	10
300mm	1	808 A121300	10
350mm	1	808 A121350	10
400mm	1	808 A121400	10
450mm	1	808 A121450	10
500mm	1	808 A121500	10
550mm	1	808 A121550	10

## Drawer Sides Industrial Package

Nominal length NL	Item NO	Set/cdn
270mm	808CB121270	10
300mm	808CB121300	10
350mm	808CB121350	10
400mm	808CB121400	10
450mm	808CB121450	10
500mm	808CB121500	10
550mm	808CB121550	10



## Sides Industrial Package

Nominal length NL	Soft close drawer item NO.	Set/cdn
270mm	808CJH270	10
300mm	808CJH300	10
350mm	808CJH350	10
400mm	808CJH400	10
450mm	808CJH450	10
500mm	808CJH500	10
550mm	808CJH550	10

## The basic components

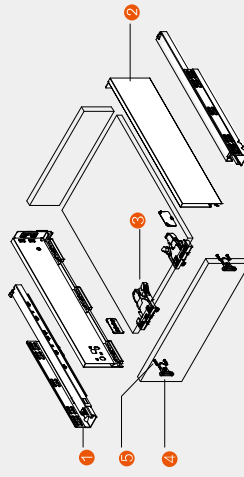

## Bottom Fixing-brackets left/right

Item NO.	808BB1000M	Set/cdn
		100

## Front Fixing-brackets

Item NO.	808Q104	Set/cdn
		400

## Screw

Item NO.	908LS114	Set/cdn
		500

## Installation dimensions (mm)

Nominal Slide Length=NL Internal Cabinet Depth=L=L+NL+3

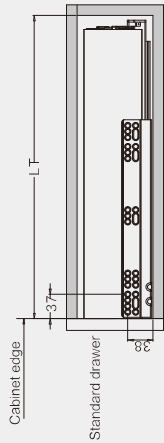

## Drawer installation dimensions (mm)

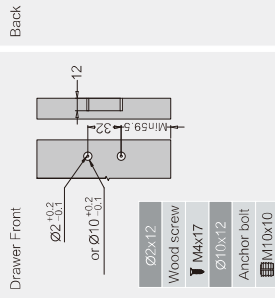

## Screw Positions of the Sides (mm)

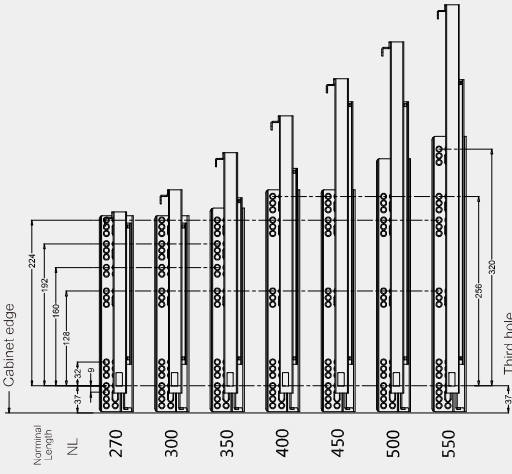

## Installation Dimensions (mm)

LW Internal cabinet width

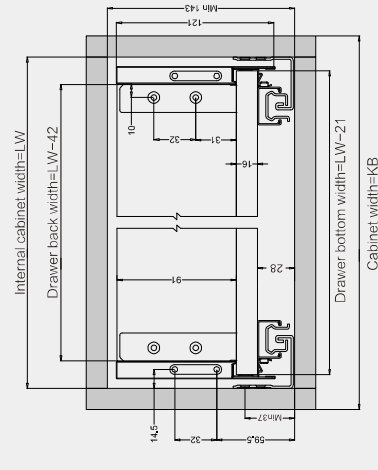

## Drawer Back and Bottom Dimensions (mm)

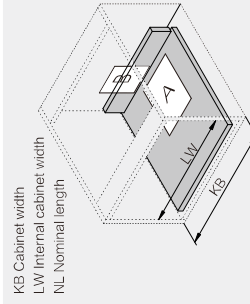
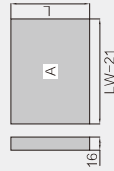
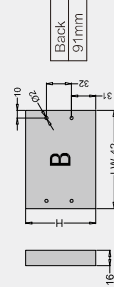

# Ray hộp âm 7273022

## NL: 500mm

808 SERIES



- Extra slender side panel , maximizing internal drawer space
- Color White (8081), Grey(8082)
- Fully synchronised motion , smooth opening and closing
- Quick and easy assembly and dismantling
- Handy, 3D three dimensional front adjustment
- Dynamic loading 40 Kg
- Optional tilting adjustment

### Space Requirement

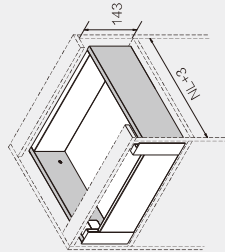

NL Nominal length

### Order information

Kit package		Sides Industrial Package	
Nominal length NL	Soft close drawer Item NO.	Pre-zinc Steel	Soft close drawer Item NO.
270mm	808 A121270N		808C-JH270
300mm	808 A121300N		808C-JH300
350mm	808 A121350N		808C-JH350
400mm	808 A121400N		808C-JH400
450mm	808 A121450N		808C-JH450
500mm	808 A121500N		808C-JH500
550mm	808 A121550N		808C-JH550

### Drawer Sides Industrial Package

White (8081) , Grey(8082)	Industrial Package
Item No	Set/cdn
808CB121270	10
808CB121300	10
808CB121350	10
808CB121400	10
808CB121450	10
808CB121500	10
808CB121550	10

### Locking brackets L/R

Industrial Package	
Item NO.	Set/cdn
808BB1000M	100

808-121-2 Front Fixing brackets L/R	
White, Gray	Industrial Package
Item NO.	Set/cdn
808BQ330	25

808-1 Front section	
White (8081) , Grey(8082)	Industrial Package
Item NO.	Set/cdn
808NCMB01	25

  

Screw ( Φ 4x25 )	
Zinc Plated	Industrial Package
Item NO.	Set/cdn
908LS115	500

  

808 Bottom fixed	
White	Industrial Package
Item NO.	Set/cdn
808DBGDU	400

### The basic components

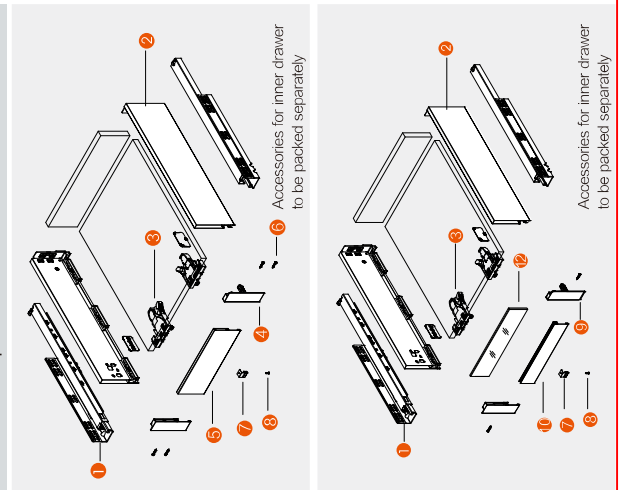

808-1 Front section

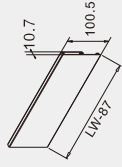

Back

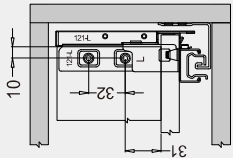

808-2 Front section

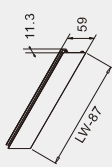

Screw ( Φ 3.5x13 )		Industrial Package	
Zinc Plated	Set/cdn	Item NO.	Set/cdn
	500	908LS116	500

  

808-121-2 Front Fixing brackets L/R	
White, Gray	Industrial Package
Item NO.	Set/cdn
808BQ130	25

808-2 Front section	
White (8081) , Grey(8082)	Industrial Package
Item NO.	Set/cdn
808NCMB02	25

### Screw Positions of the Sides (mm)

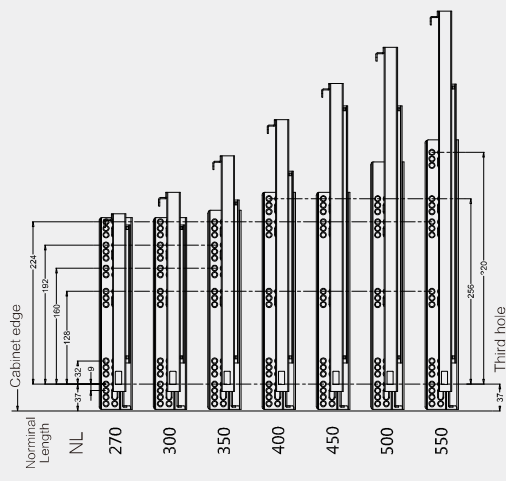

808-121 Glass Front		Industrial Package	
Glass front	Set/cdn	Item NO.	Set/cdn
Glass boxside	10	808BLMB02	10

### Drawer Back and Bottom Dimensions (mm)

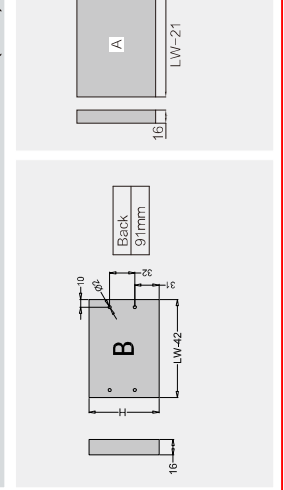

### Installation Dimensions (mm)

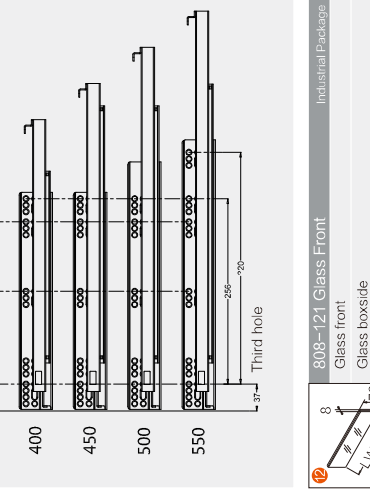

LW Internal cabinet width

Drawer back width=LW-42

Drawer bottom width=LW-21

Cabinet width=KB

Normal Slide Length=NL Internal Cabinet Depth=L T=NL+3

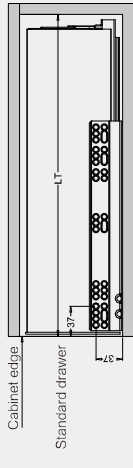

Cabinet edge

Standard drawer

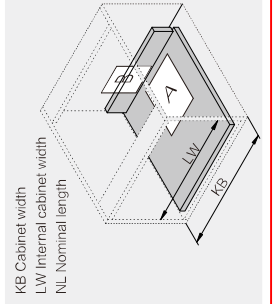

KB Cabinet width

LW Internal cabinet width

NL Nominal length

# Ray hộp 7273017

## NL: 500mm

808 SERIES



- Extra slender side panel, maximizing internal drawer space
- Color White (8081), Grey (8082)
- Fully synchronised motion, smooth opening and closing
- Quick and easy assembly and dismantling
- Handy 3D three dimensional front adjustment
- Dynamic loading 40 Kg
- Optional tilting adjustment

### Space Requirement

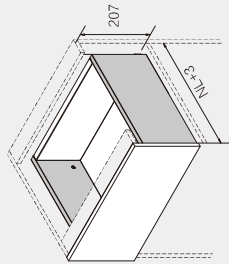

NL Nominal length

### Order information

Kit package		White (8081) , Grey(8082)		Soft close drawer item NO.		Set/cdn	
Nominal length NL	Item NO.	Set/cdn	Industrial Package	Nominal length NL	Soft close drawer item NO.	Set/cdn	Industrial Package
270mm	808 A185270	1		270mm	808C-JH270	10	
300mm	808 A185300	1		300mm	808C-JH300	10	
350mm	808 A185350	1		350mm	808C-JH350	10	
400mm	808 A185400	1		400mm	808C-JH400	10	
450mm	808 A185450	1		450mm	808C-JH450	10	
500mm	808 A185500	1		500mm	808C-JH500	10	
550mm	808 A185550	1		550mm	808C-JH550	10	

### Drawer Sides Industrial Package

Nominal length NL	Item NO.	Set/cdn
270mm	808CB185270	10
300mm	808CB185300	10
350mm	808CB185350	10
400mm	808CB185400	10
450mm	808CB185450	10
500mm	808CB185500	10
550mm	808CB185550	10

### The basic components

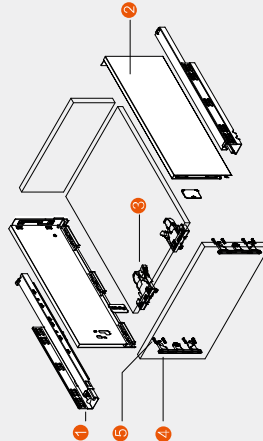

### Bottom Fixing-brackets left/right

Item NO.	808BB1000M	Set/cdn	Industrial Package
		100	

### Front Fixing-brackets

Pre-zinc Steel		Industrial Package	
Item NO.	8080Q114	Set/cdn	Industrial Package
		100	

### Screw

Zinc Plated		Industrial Package	
Item NO.	908LS114	Set/cdn	Industrial Package
		500	

### Installation dimensions (mm)

Nominal Slide Length=NL Internal Cabinet Depth=L=L+3

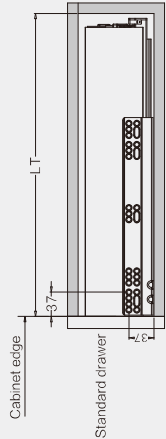

### Drawer installation dimensions (mm)

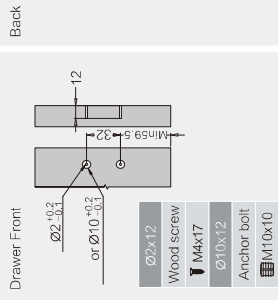

### Screw Positions of the Sides (mm)

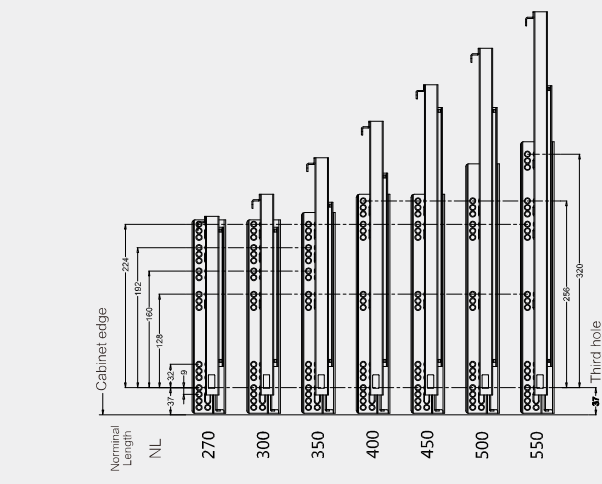

### Installation Dimensions (mm)

LW Internal cabinet width

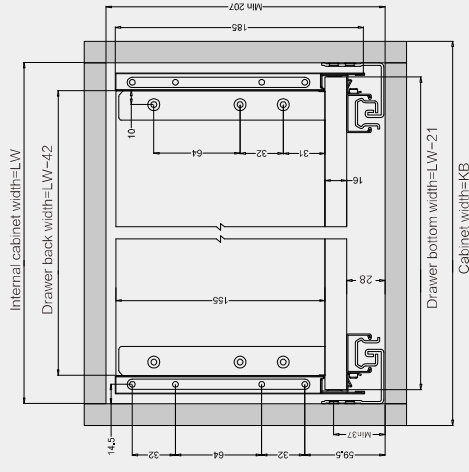

### Drawer Back and Bottom Dimensions (mm)

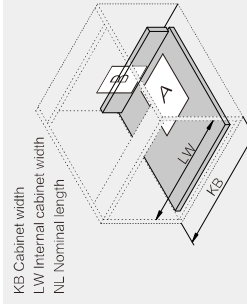
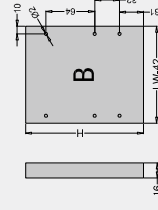

# Ray hộp âm 7273023

## NL: 500mm

808 SERIES



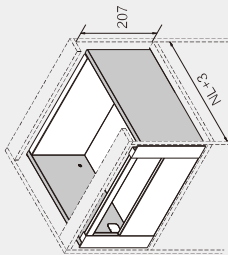

- Extra slender side panel , maximizing internal drawer space
- Color White (8081), Grey(8082)
- Fully synchronised motion , smooth opening and closing
- Quick and easy assembly and dismantling
- Handy, 3D three dimensional front adjustment
- Dynamic loading 40 Kg
- Optional tilting adjustment

### Space Requirement



NL Nominal length

### Order information

K/ft package	Soft close drawer		Set/cdn
	White (8081) , Grey(8082)	Item NO.	
	Nominal length NL	Soft close drawer Item NO.	Set/cdn
	270mm	808CJH270	10
	300mm	808CJH300	10
	350mm	808CJH350	10
	400mm	808CJH400	10
	450mm	808CJH450	10
	500mm	808CJH500	10
	550mm	808CJH550	10

### Drawer Sides Industrial Package

White (8081) , Grey(8082)	Item NO.	Set/cdn	Industrial Package
Nominal length NL			
270mm	808CB185270	10	
300mm	808CB185300	10	
350mm	808CB185350	10	
400mm	808CB185400	10	
450mm	808CB185450	10	
500mm	808CB185500	10	
550mm	808CB185550	10	

### Locking brackets L/R

White, Grey	Item NO.	Set/cdn	Industrial Package
Nominal length NL			
270mm	808BB1000M	100	

### 808-185-2 Front Fixing brackets L/R

White, Grey	Item NO.	Set/cdn	Industrial Package
Nominal length NL			
270mm	808BQ530	25	

### 808-1 Front section

White (8081) , Grey(8082)	Item NO.	Set/cdn	Industrial Package
Nominal length NL			
270mm	808NCMB01	25	

### Screw (φ 3.5x13)

Zinc Plated	Item NO.	Set/cdn	Industrial Package
Nominal length NL			
270mm	908LS115	500	

### 808 Bottom fixed

White	Item NO.	Set/cdn	Industrial Package
Nominal length NL			
270mm	808DBGDU	400	

Screw (φ 3.5x13)	Item NO.	Set/cdn	Industrial Package
Zinc Plated	908LS116	500	

808-185-2 Front Fixing brackets L/R	Item NO.	Set/cdn	Industrial Package
White, Grey	808BQ530	25	

808-2 Front section	Item NO.	Set/cdn	Industrial Package
White (8081) , Grey(8082)	808NCMB02	25	

Cross square rail	Item NO.	Set/cdn	Industrial Package
White, Grey(7088)	908NL220503	25	

### Screw Positions of the Sides (mm)

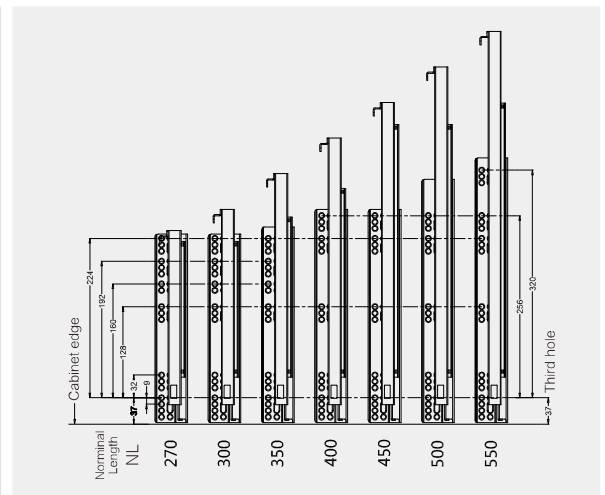

808-185 Glass Front	Item NO.	Set/cdn	Industrial Package
Glass front	808BLV030	10	

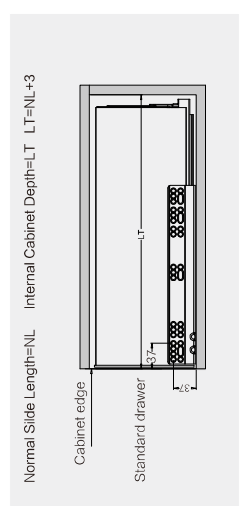
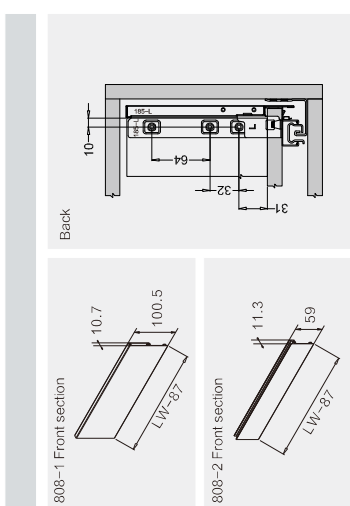

### Installation Dimensions (mm)

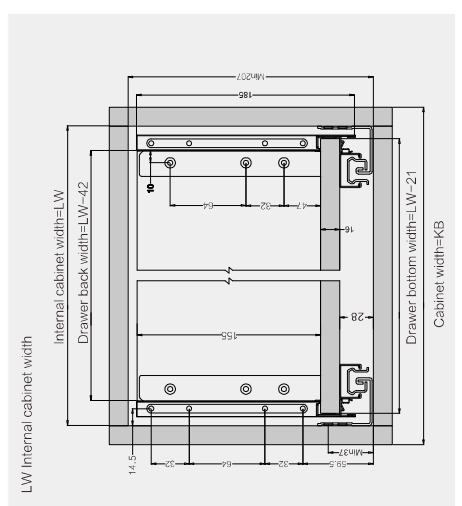

### Drawer Back and Bottom Dimensions (mm)

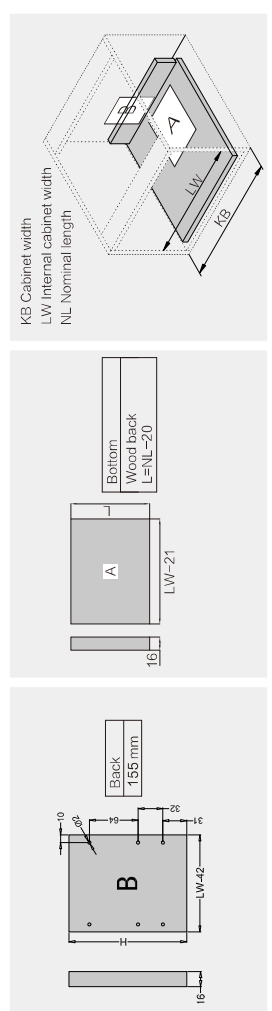

# Ray hộp 7273002

## NL: 500mm

908 SERIES

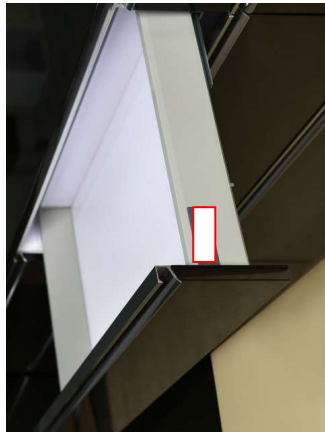

- Concealed full extension, synchronised slides
- White, silver grey (7088), stainless steel (SUS)
- Light opening & closing, smooth sliding
- Quick installation and easy dismounting
- Integrated 3D front panel adjustment
- Dynamic loading capacity: 35kg

### Space Requirement

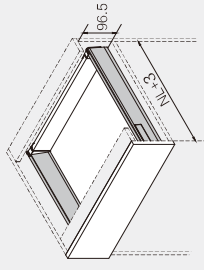

NL Nominal length

### Order information

Kit package		White, Silver Grey(7088), Stainless Steel(SUS)	
Nominal length NL	Soft close drawer item NO.	Push-open drawer item NO.	Set/cdn
270mm	TB84F270	TB84F270	1
300mm	TB84F300	TB84F300	1
350mm	TB84F350	TB84F350	1
400mm	TB84F400	TB84F400	1
450mm	TB84F450	TB84F450	1
500mm	TB84F500	TB84F500	1
550mm	TB84F550	TB84F550	1

Sides Industrial Package		Pre-zinc Steel	
Nominal length NL	Soft close drawer item NO.	Push-open drawer item NO.	Set/cdn
270mm	908TB114270	908TB214270	10
300mm	908TB114300	908TB214300	10
350mm	908TB114350	908TB214350	10
400mm	908TB114400	908TB214400	10
450mm	908TB114450	908TB214450	10
500mm	908TB114500	908TB214500	10
550mm	908TB114550	908TB214550	10

### Drawer Sides Industrial Package

Nominal length NL	Item NO.	Set/cdn
270mm	908TC120270	10
300mm	908TC120300	10
350mm	908TC120350	10
400mm	908TC120400	10
450mm	908TC120450	10
500mm	908TC120500	10
550mm	908TC120550	10

### Back Fixing-brackets left/right

Industrial Package	
Item NO.	Set/cdn
908BB120084	100

  

Industrial Package	
Item NO.	Set/cdn
908BQ214	400pairs

Industrial Package	
Item NO.	Set/cdn
908LS114	500

### The basic components

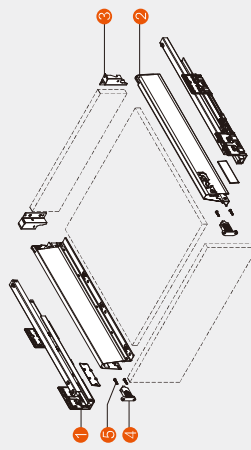

### Installation dimensions (mm)

Nominal Slide Length=NL Internal Cabinet Depth=LT=NL+3

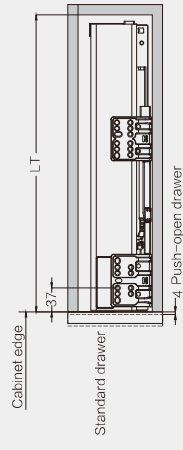

### Drawer installation dimensions (mm)

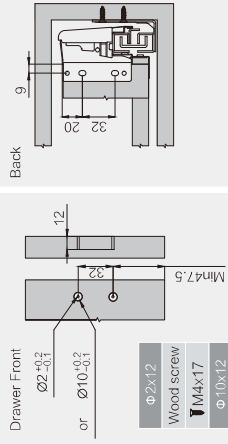

### Screw Positions of the Sides (mm)

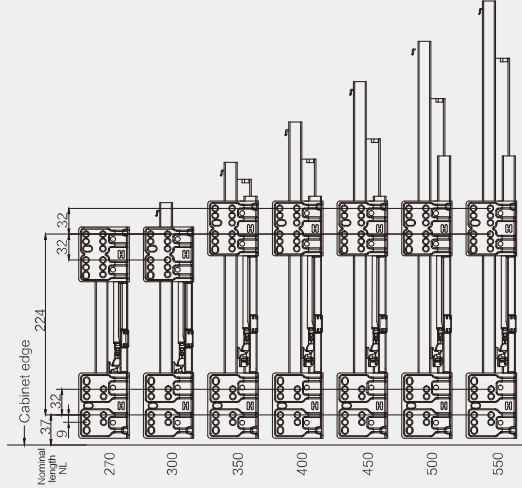

### Installation Dimensions (mm)

LW Internal cabinet width

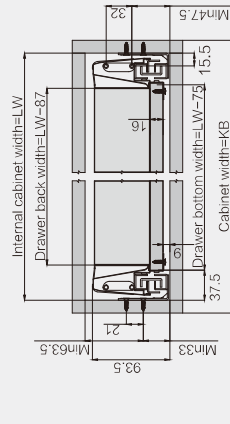

### Drawer Back and Bottom Dimensions (mm)

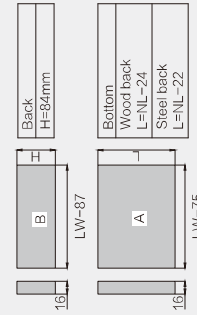
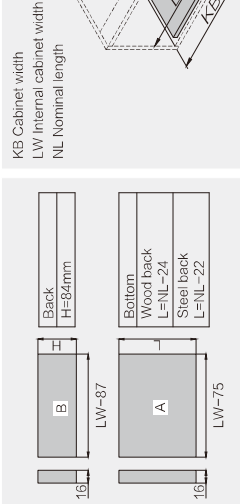

# Ray hộp âm 7273018

## NL: 500mm

908 SERIES



- Concealed full extension, synchronised slides
- White, silver grey (7088), stainless steel (SUS)
- Light opening & closing, smooth sliding
- Quick installation and easy dismounting
- Integrated 3D front panel adjustment
- Dynamic loading capacity: 35kg

### Space Requirement

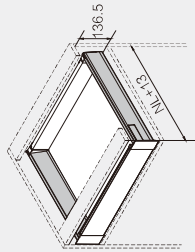

NL Nominal length

### Order information

Kit package		White, Silver Grey(7088), Stainless Steel(SUS)	
Nominal length NL	Soft close drawer item NO.	Push-open drawer item NO.	Set/cdn
270mm	TB84270N	TB84F270N	1
300mm	TB84300N	TB84F300N	1
350mm	TB84350N	TB84F350N	1
400mm	TB84400N	TB84F400N	1
450mm	TB84450N	TB84F450N	1
500mm	TB84500N	TB84F500N	1
550mm	TB84550N	TB84F550N	1



### Sides Industrial Package

Pre-zinc Steel		Push-open drawer item NO.	
Nominal length NL	Soft close drawer item NO.	Push-open drawer item NO.	Set/cdn
270mm	908TB114270	908TB214270	10
300mm	908TB114300	908TB214300	10
350mm	908TB114350	908TB214350	10
400mm	908TB114400	908TB214400	10
450mm	908TB114450	908TB214450	10
500mm	908TB114500	908TB214500	10
550mm	908TB114550	908TB214550	10

### Drawer Sides Industrial Package

White, Silver Grey(7088), Stainless Steel(SUS)	Item NO.	Set/cdn
270mm	908TC120270	10
300mm	908TC120300	10
350mm	908TC120350	10
400mm	908TC120400	10
450mm	908TC120450	10
500mm	908TC120500	10
550mm	908TC120550	10

### The basic components

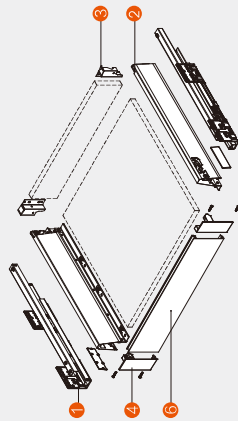

Note: Front section not included in the kit package



### Back Fixing-brackets left/right

White, Silver Grey(7088), Stainless Steel(SUS)		Industrial Package	
Item NO.	908BB120084	Set/cdn	100



### Front Fixing-brackets left/right

White, Grey		Industrial Package	
Item NO.	908EQ130	Set/cdn	25



White, Silver Grey(7088), Stainless Steel(SUS)		Industrial Package	
Item NO.	908LB220503	Set/cdn	25

### Installation dimensions (mm)

Nominal Slide Length=NL Internal Cabinet Depth=L+NL+13

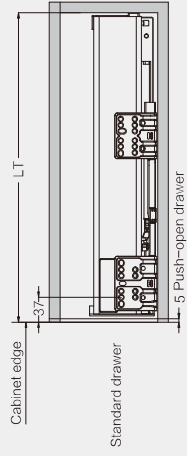

### Drawer installation dimensions (mm)

Inner Front section

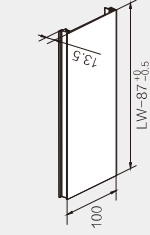

Back

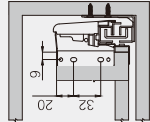

### Screw Positions of the Sides (mm)

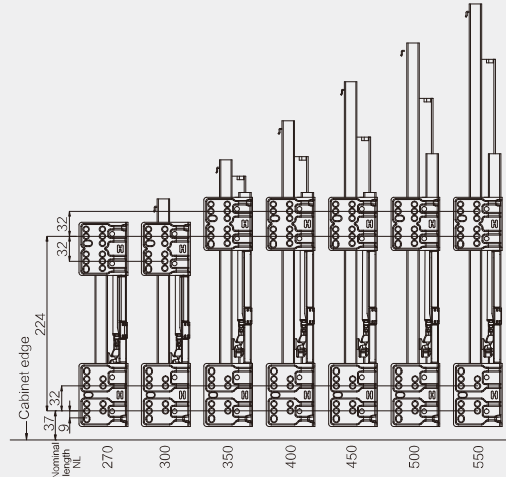

### Installation Dimensions (mm)

LW Internal cabinet width

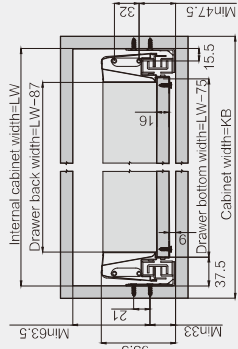

### Drawer Back and Bottom Dimensions (mm)

KB Cabinet width  
LW Internal cabinet width  
NL Nominal length

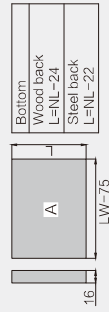
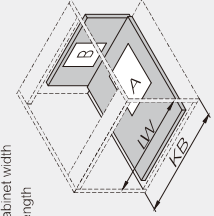





# Ray hộp âm 7273019

## NL: 500mm

908 SERIES

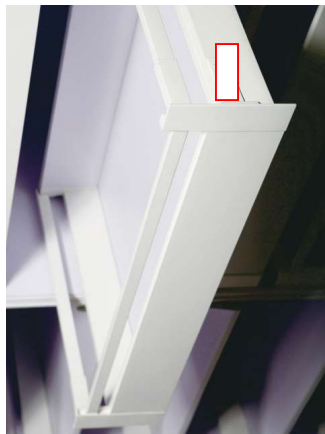

- Concealed full extension, synchronised slides
- White, silver grey (7088), stainless steel (SUS)
- Light opening & closing, smooth sliding
- Quick installation and easy dismounting
- Integrated 3D front panel adjustment
- Dynamic loading capacity: 35kg

### Space Requirement

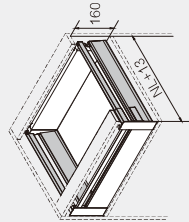

NL Nominal length

### Order information

Kit package		White, Silver Grey(7088), Stainless Steel(SUS)	
Nominal length NL	Soft close drawer item NO.	Push-open drawer item NO.	Self/cdn
270mm	TB135270N	TB135F270N	1
300mm	TB135300N	TB135F300N	1
350mm	TB135350N	TB135F350N	1
400mm	TB135400N	TB135F400N	1
450mm	TB135450N	TB135F450N	1
500mm	TB135500N	TB135F500N	1
550mm	TB135550N	TB135F550N	1

Sides Industrial Package		Pre-zinc Steel	
Nominal length NL	Soft close drawer item NO.	Push-open drawer item NO.	Self/cdn
270mm	908TB114270	908TB214270	10
300mm	908TB114300	908TB214300	10
350mm	908TB114350	908TB214350	10
400mm	908TB114400	908TB214400	10
450mm	908TB114450	908TB214450	10
500mm	908TB114500	908TB214500	10
550mm	908TB114550	908TB214550	10

### Drawer Sides Industrial Package

Nominal length NL	Item NO.	Self/cdn	White, Silver Grey(7088), Stainless Steel(SUS)
270mm	908TC120270	10	LGf1270MX
300mm	908TC120300	10	LGf1300MX
350mm	908TC120350	10	LGf1350MX
400mm	908TC120400	10	LGf1400MX
450mm	908TC120450	10	LGf1450MX
500mm	908TC120500	10	LGf1500MX
550mm	908TC120550	10	LGf1550MX

### The basic components

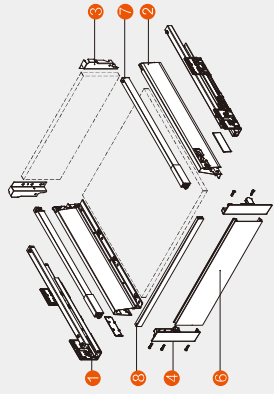

Note: Front section Cross Square Rail not included in the kit package

Back Fixing-brackets left/right Industrial Package		White, Silver Grey(7088), Stainless Steel(SUS)	
Item NO.	Self/cdn	Item NO.	Self/cdn
908BB120135	50		
Front Fixing-brackets left/right Industrial Package		White, Grey	
Item NO.	Self/cdn	Item NO.	Self/cdn
908BQ230	25		
Front Section Industrial Package		White, Silver Grey(7088), Stainless Steel(SUS)	
Item NO.	Self/cdn	Item NO.	Self/cdn
908B220503	25		
Cross Square Rail Industrial Package		White, Silver Grey(7088), Stainless Steel(SUS)	
Item NO.	Self/cdn	Item NO.	Self/cdn
908NL220503	25		

### Drawer installation dimensions(mm)

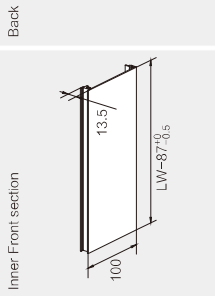

### Installation dimensions(mm)

Nominal Slide Length=NL Internal Cabinet Depth=L=L+13

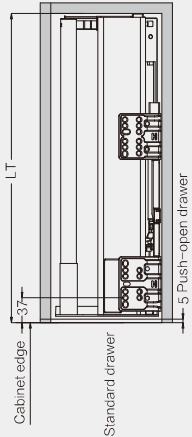

### Installation Dimensions(mm)

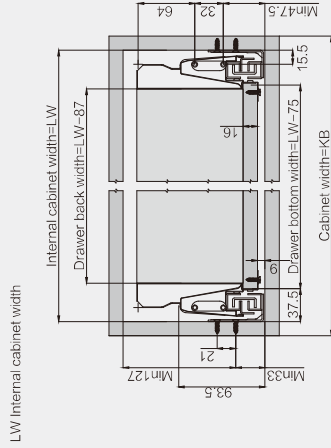

### Screw Positions of the Sides(mm)

Nominal length NL

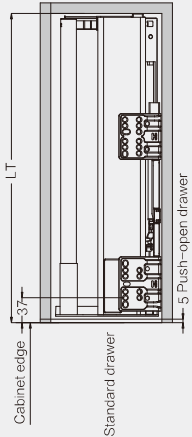

### Drawer Back and Bottom Dimensions(mm)

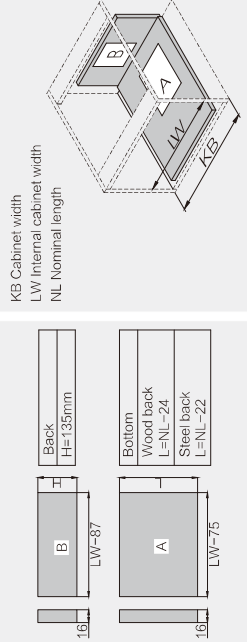



# Ray hộp âm 7273020

## NL: 500mm

908 SERIES



- Concealed/full extension, synchron -ised slides
- White, silver grey (7088), stainless steel (SUS)
- Light opening & closing, smooth sliding
- Quick installation and easy dism -antling
- Integrated 3D front panel adjust -ment
- Dynamic loading capacity : 35kg

### Space Requirement

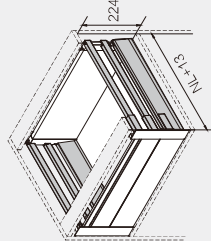

NL Nominal length

### Order information

Kit package		White, Silver Grey(7088), Stainless Steel(SUS)	
Nominal length NL	Soft close drawer item NO.	Push-open drawer item NO.	Set/cdn
270mm	TB199270N	TB199270N	1
300mm	TB199300N	TB199300N	1
350mm	TB199350N	TB199350N	1
400mm	TB199400N	TB199400N	1
450mm	TB199450N	TB199450N	1
500mm	TB199500N	TB199500N	1
550mm	TB199550N	TB199550N	1

Sides Industrial Package		Pre-zinc Steel	
Nominal length NL	Soft close drawer item NO.	Push-open drawer item NO.	Set/cdn
270mm	908TB114270	908TB214270	10
300mm	908TB114300	908TB214300	10
350mm	908TB114350	908TB214350	10
400mm	908TB114400	908TB214400	10
450mm	908TB114450	908TB214450	10
500mm	908TB114500	908TB214500	10
550mm	908TB114550	908TB214550	10

### Drawer Sides Industrial Package

Nominal length NL	White, Silver Grey(7088), Stainless Steel(SUS)	Set/cdn
270mm	908TC120270	10
300mm	908TC120300	10
350mm	908TC120350	10
400mm	908TC120400	10
450mm	908TC120450	10
500mm	908TC120500	10
550mm	908TC120550	10

### Rails left/right

Nominal length NL	White, Silver Grey(7088), Stainless Steel(SUS)	Item NO.	Set/cdn
270mm	LGf1270MX	25	
300mm	LGf1300MX	25	
350mm	LGf1350MX	25	
400mm	LGf1400MX	25	
450mm	LGf1450MX	25	
500mm	LGf1500MX	25	
550mm	LGf1550MX	25	

### Mid Rails left/right

Nominal length NL	White, Silver Grey(7088), Stainless Steel(SUS)	Item NO.	Set/cdn
270mm	LGf2270MX	25	
300mm	LGf2300MX	25	
350mm	LGf2350MX	25	
400mm	LGf2400MX	25	
450mm	LGf2450MX	25	
500mm	LGf2500MX	25	
550mm	LGf2550MX	25	

### Back Fixing-brackets left/right

Item NO.	White, Silver Grey(7088), Stainless Steel(SUS)	Set/cdn
908BB120199	Industrial Package	40

### Front Fixing-brackets left/right

Item NO.	Grey, White	Set/cdn
908BQ330	Industrial Package	25

### Front Section

Item NO.	White, Silver Grey(7088), Stainless Steel(SUS)	Set/cdn
908LB220503	Industrial Package	25

### Cross Square Rail

Item NO.	White, Silver Grey(7088), Stainless Steel(SUS)	Set/cdn
908NL220503	Industrial Package	25

### The basic components

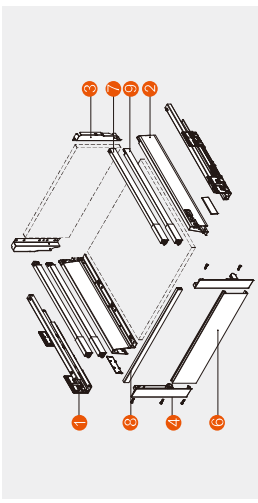

Note: Front section, Cross Square Rail not included in the kit package

### Drawer installation dimensions(mm)

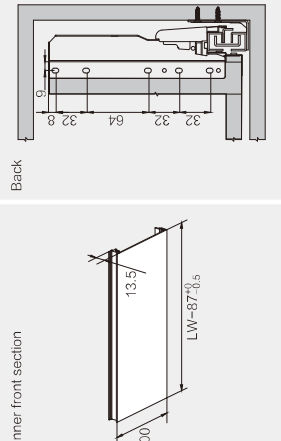

### Installation dimensions(mm)

Nominal Slide Length=NL Internal Cabinet Depth=L=L+NL+13

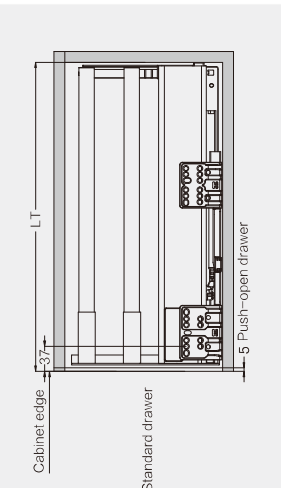

### Screw Positions of the Sides(mm)

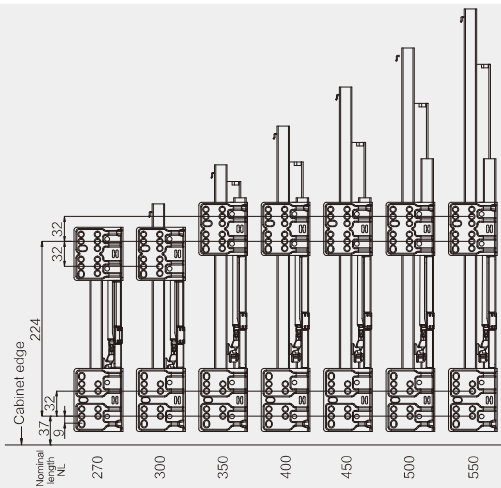

### Installation Dimensions(mm)

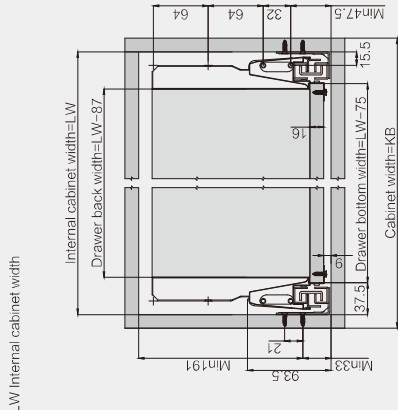

### Drawer Back and Bottom Dimensions(mm)

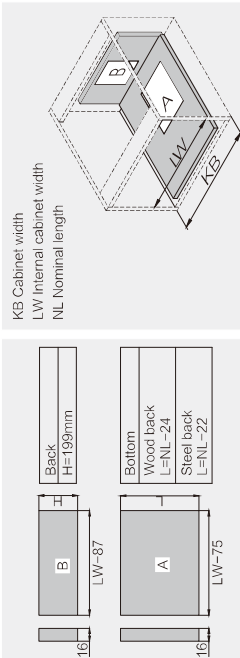



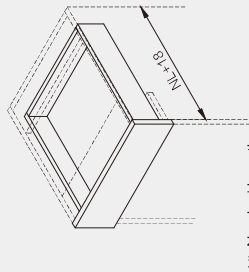

- Perfect light, smooth, silent self & soft close system
- Quick and easy assembling and dismantle the drawer
- Height adjustment 0 ~ +3mm
- Loading capacity 25KG

### Space requirement



NL Nominal Length

### Ordering information

Runners left / right	Max 16mm item No.	Max 19mm item No.	Set / ctn.
	708BJH-300	708BJH(19)-300	10
	708BJH-350	708BJH(19)-350	10
	708BJH-400	708BJH(19)-400	10
	708BJH-450	708BJH(19)-450	10
	708BJH-500	708BJH(19)-500	10
	708BJH-550	708BJH(19)-550	10
Locking Brackets #5 Left / Right			
	Item No.	272000-BS05-00001	
Locking Brackets #8B Left / Right			
	Item No.	272000-BS08B00001	

### Basic components

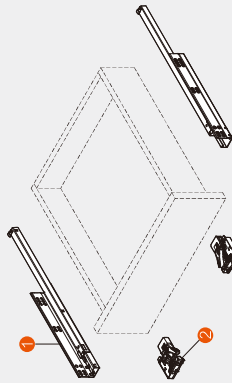

### Installation Dimensions (mm)

Installation for drawer with max 19mm thick drawer side  
 LW=Internal Cabinet Width SKW=Internal drawer Width

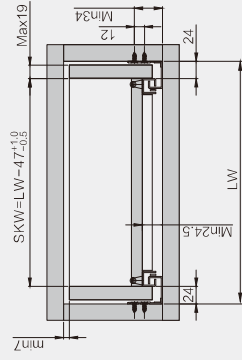

### Installation Dimensions (mm)

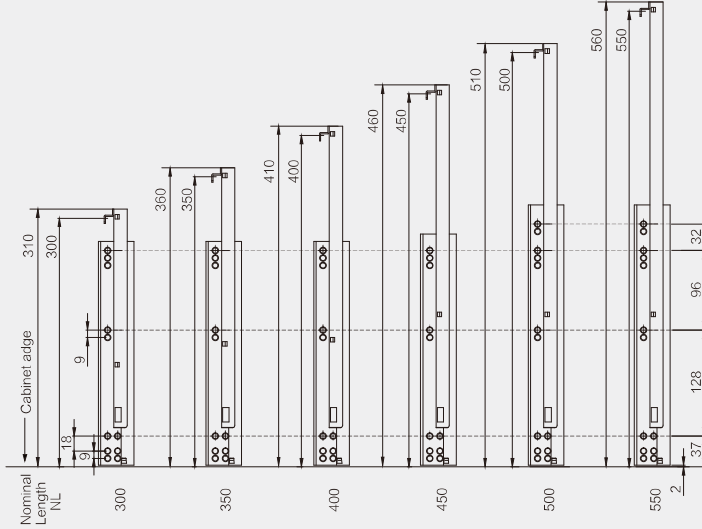

### Drawer Dimensions (mm)

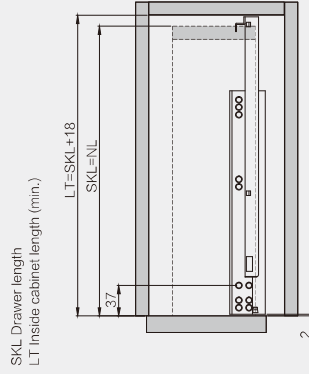

### Drawer box specification (mm)

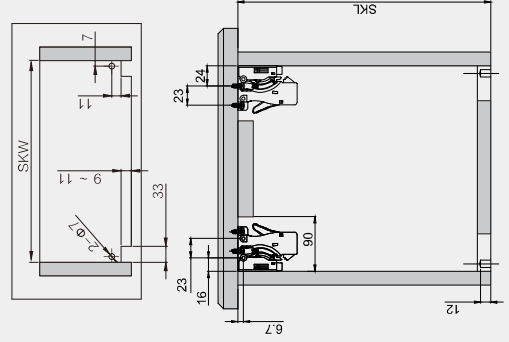



- Synchronized more light, more silent, more smooth, self & soft close system
- Quick and easy assembling and dismantle the drawer
- Height adjustment 0~+3mm
- Side adjustment ± 1.5mm
- Depth (In and Out) adjustment 0~+3mm
- Loading capacity 40KG

### Space requirement

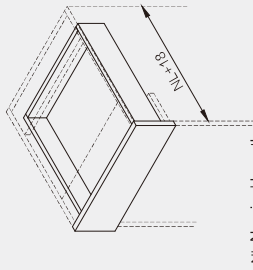

### Ordering information

Runners left / right			
Nominal Length	Max 16mm item No.	Max 19mm item No.	Set / ctn.
270mm	728CFH-270	728CFH(19)-270	10
300mm	728CFH-300	728CFH(19)-300	10
350mm	728CFH-350	728CFH(19)-350	10
400mm	728CFH-400	728CFH(19)-400	10
450mm	728CFH-450	728CFH(19)-450	10
500mm	728CFH-500	728CFH(19)-500	10
550mm	728CFH-550	728CFH(19)-550	10

  

Locking Brackets #10 Left / Right	
Item No.	27Z000-BS10-00001
Side adjustment ± 1.5mm	

Locking Brackets #10-2 Left / Right	
Item No.	27Z000-BS10-00002
Side adjustment ± 1.5mm,	
Depth (In and Out) adjustment 0 - +3mm	

### Basic components

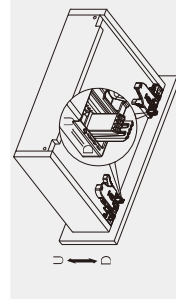
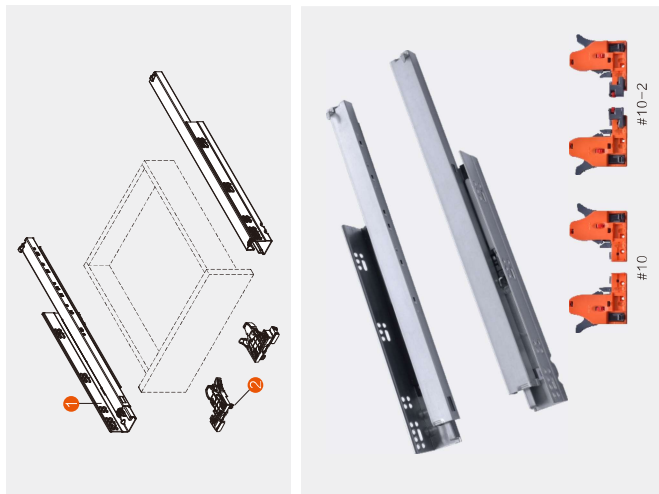

Height adjustment 0~+3mm

※ Side adjustment ± 1.5mm, provided that the width of the drawer is within tolerance.

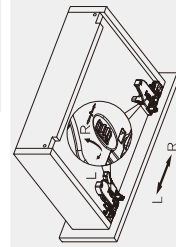

Side adjustment ± 1.5mm

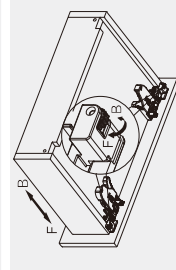

Depth (In and Out) adjustment 0~+3mm

### Installation Dimensions (mm)

Installation for drawer with max 16mm thick drawer side  
 LW=internal Cabinet Width SKW=internal drawer Width

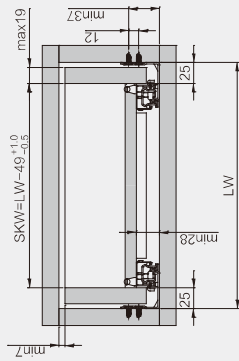

### Installation Dimensions (mm)

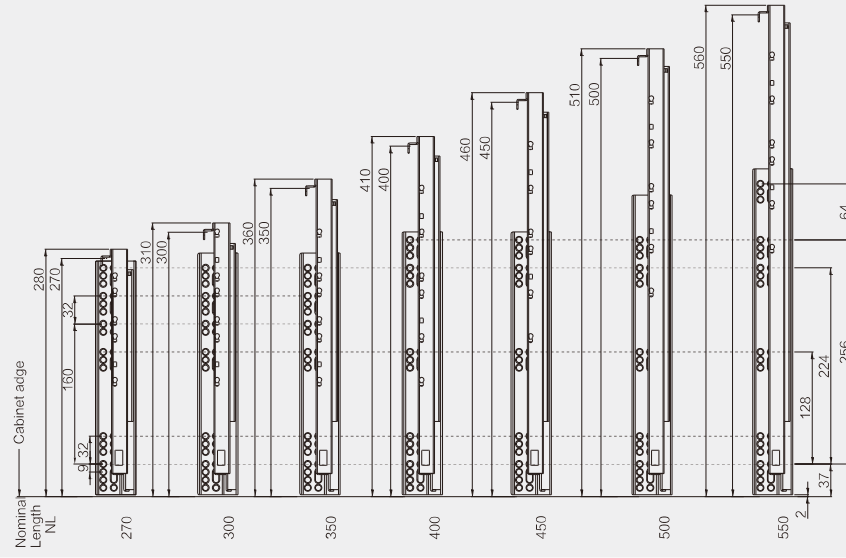

### Drawer Dimensions (mm)

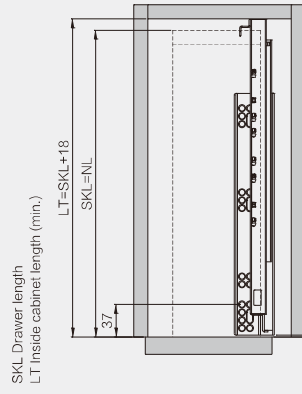

### Drawer box specification (mm)

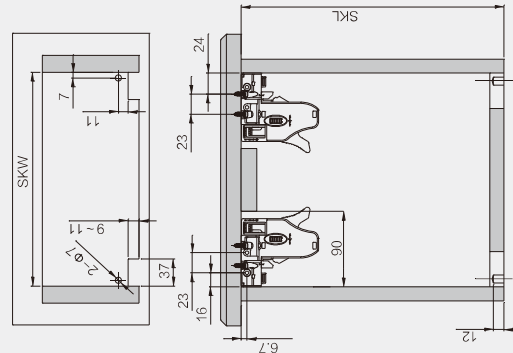

## TM ZN45405

Soft close Full extension ball bearing slide  
 Side clearance 12.7<sup>+0.1</sup><sub>-0.2</sub>mm (1/2")  
 Loading capacity 45kg(100lbs)

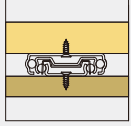

Suitable for wooden cabinets

- Application: General home furniture or other drawer applications.
- Feature: Full extension. Lever disconnect for drawer removal. Less noise at closing and opening.
- Loading capacity: 45KG(100lbs).
- Material: Cold rolled steel.
- Finishes: Electro-zinc with bright, yellow, blue or black oxidized.
- Size: 300mm-700mm.
- Side clearance: minimum 12.5mm/Maximum 13.5mm.
- The ultimate clearance 12.7mm-13.2mm.
- soft closing time: 1.2-1.8s.
- soft closing distance: 40mm

Number	Drawer length	Min. cabinet depth	Qualibox
ZN45405-12	300	304	10
ZN45405-14	350	354	10
ZN45405-16	400	404	10
ZN45405-18	450	454	10
ZN45405-20	500	504	10
ZN45405-22	550	554	10
ZN45405-24	600	604	10
ZN45405-26	650	654	10
ZN45405-28	700	704	10

\*Packaging: 10 sets/box

## Assembly

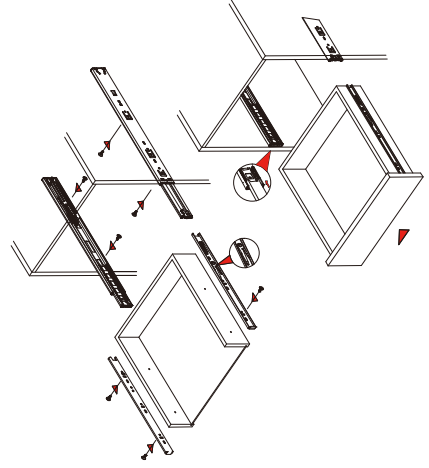
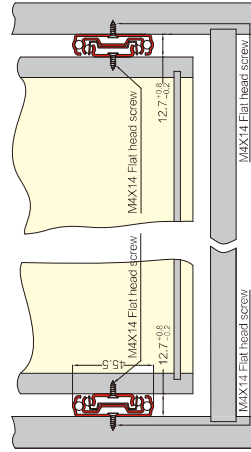

## TM ZN45405

Soft close Full extension ball bearing slide  
 Side clearance 12.7<sup>+0.1</sup><sub>-0.2</sub>mm (1/2")  
 Loading capacity 45kg(100lbs)

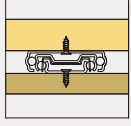

Suitable for wooden cabinets

## Hole pattern for drawers and cabinets

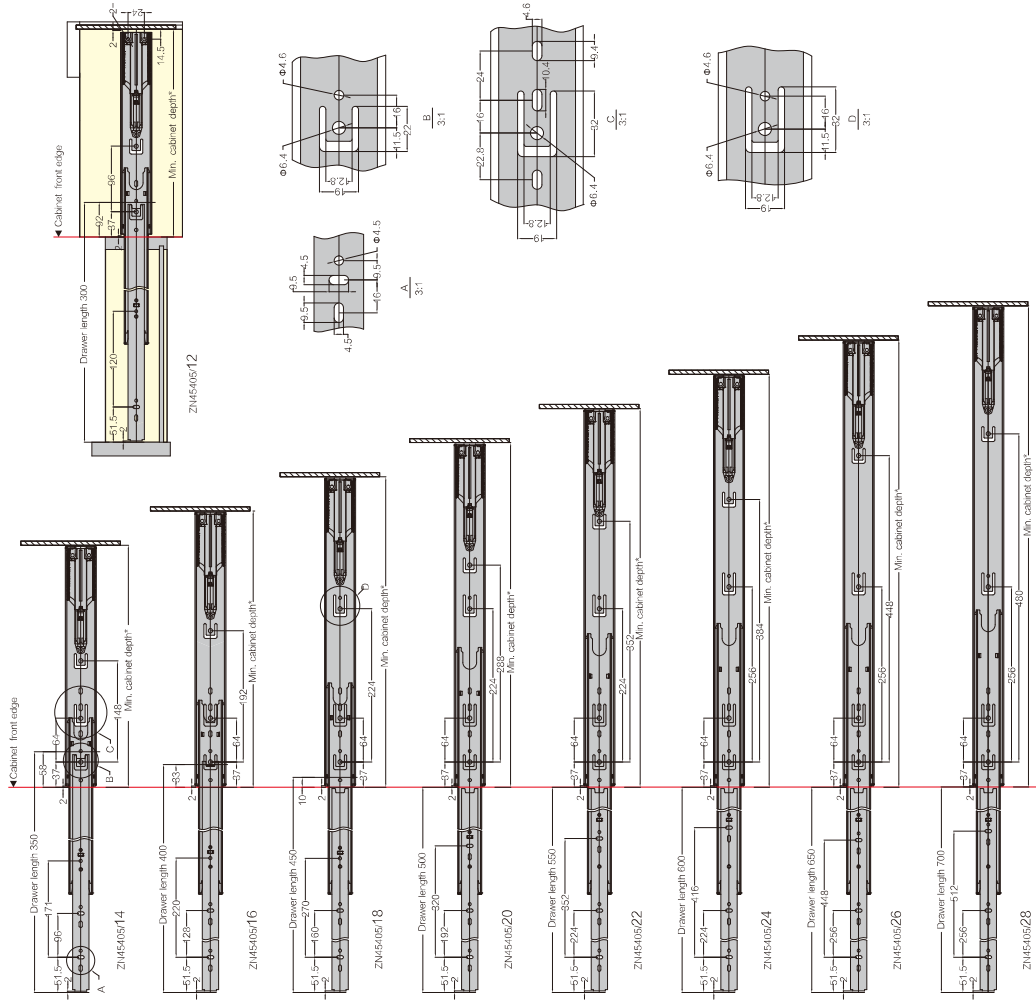

\*Min. cabinet depth = drawer length +4